

curve
ficha técnica
datasheet

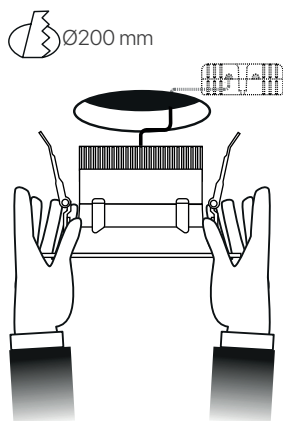

ref. 5550184

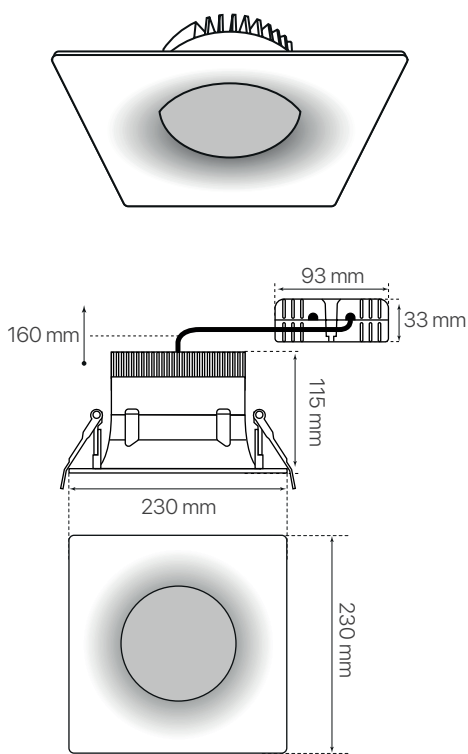

Nombre / Name	curve • downlight led cuadrado
Referencia / Reference	5550184
Materiales / Materials	Aluminio / Aluminum
Difusor / Diffuser	Cristal / Crystal
Potencia / Power	25W
Temperatura de color / Color temperature	6400K
Flujo luminoso / Luminous flux	2480lm
Dimable / Dimmable	No
Ángulo de apertura / Beam angle	60°
Ángulo de inclinación / Inclination angle	-
IP	20
IK	-
F.P	-
UGR	-
IRC	-
Chip	EPISTAR SMD
Driver	i-TEC series
Vida media (duración) / Average life	30.000 ~ 50.000h
Clase energética / Energy class	A
Aislamiento eléctrico / Electrical isolation	-
Colores / Colors	Blanco / White
Medida exterior / Product size	230mm x 230mm x 115mm
Medidas de corte / Cutting measurements	Ø200mm
Tª (ambiente/trabajo) / Tª (enviroment/work)	-20°C ~ 40°C
Input	AC100 ~ 240V
Output	DC23 ~ 43V 670mA
Frecuencia / Frequency	50 / 60Hz
Peso / Weight	1,320kg
Certificados / Certificates	CE
Garantía / Warranty	2 años / 2 years